

# RF/Microwave Capacitors

## RF/Microwave Multilayer Capacitors (MLC)

### 600S Ultra-Low ESR, High Q, NPO Capacitors

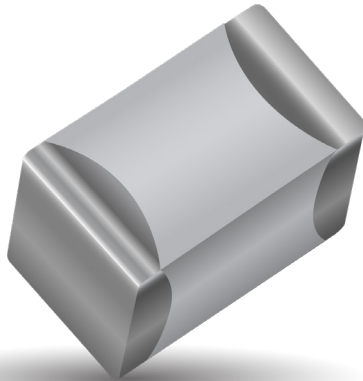

## FEATURES

- Lowest ESR in Class
- Highest Working Voltage in Class - 250 V
- Standard EIA Size: 0603
- Laser Marking (Optional)
- High Self-Resonance Frequencies

## 600 SERIES OVERVIEW

Series	Case Size	EIA Case Size
600	L	0402
600	S	0603
600	F	0805

## APPLICATIONS

- Cellular Base Stations
- Broadband Wireless Services
- Satellite Communications
- Subscriber-based Wireless Devices
- WiFi (802.11)
- Public Safety Radio

## CIRCUIT APPLICATIONS

- Filter Networks
- High Q Frequency Sources
- Matching Networks
- Tuning, Coupling, Bypass and DC Blocking

## ELECTRICAL SPECIFICATIONS

<b>Capacitance</b>	0.1 to 100 pF
<b>Tolerances</b>	See Cap Value Chart
<b>Working Voltage (WVDC)</b>	250 V
<b>Quality Factor (Q)</b>	> 2000 @ 1 MHz
<b>Operating Temperature Range</b>	-55°C to +125°C (no derating of working voltage)
<b>Temperature Coefficient of Capacitance (TCC)</b>	0 ± 30 ppm/°C, -55°C to +125°C 10 <sup>5</sup> MΩ min. at +25°C at rated WVDC 10 <sup>4</sup> MΩ min. at +125°C at rated WVDC
<b>Dielectric Withstanding Voltage (DWV)</b>	2.5 x WVDC for 5 seconds
<b>Aging</b>	None
<b>Piezo Effects</b>	None

## PACKAGING OPTIONS



Tape & Reel



Vertical Orientation Tape & Reel



## ENVIRONMENTAL CHARACTERISTICS

<b>Thermal Shock</b>	5 Cycles, -55°C to 125°C
<b>Moisture Resistance</b>	Mil-STD-202, Method 106
<b>Life Test</b>	2000 hours at 125°C at 2X WVDC
<b>Solderability</b>	Solder Coverage > 90% of end termination
<b>Terminal Strength</b>	4 lbs. typ., 2 lb. min.
<b>Military Approval</b>	DSCC Drawing Number 05002

# RF/Microwave Capacitors

## RF/Microwave Multilayer Capacitors (MLC)

### 600S Ultra-Low ESR, High Q, NPO Capacitors



## CAPACITANCE VALUES

Value (pF)	Cap Code	Marking	Tolerances	Value (pF)	Cap Code	Marking	Tolerances	Value (pF)	Cap Code	Marking	Tolerances
0.1	0R1	A9	A, B	2.7	2R7	L0	A, B, C, D	20	200	H1	F, G, J, K, M
0.2	0R2	H9	A, B	3.0	3R0	M0	A, B, C, D	22	220	J1	F, G, J, K, M
0.3	0R3	M9	A, B, C	3.3	3R3	N0	A, B, C, D	24	240	K1	F, G, J, K, M
0.4	0R4	d9	A, B, C	3.6	3R6	P0	A, B, C, D	27	270	L1	F, G, J, K, M
0.5	0R5	f9	A, B, C	3.9	3R9	Q0	A, B, C, D	30	300	M1	F, G, J, K, M
0.6	0R6	m9	A, B, C	4.3	4R3	R0	A, B, C, D	33	330	N1	F, G, J, K, M
0.7	0R7	n9	A, B, C	4.7	4R7	S0	A, B, C, D	36	360	P1	F, G, J, K, M
0.8	0R8	t9	A, B, C	5.1	5R1	T0	A, B, C, D	39	390	Q1	F, G, J, K, M
0.9	0R9	y9	A, B, C	5.6	5R6	U0	A, B, C, D	43	430	R1	F, G, J, K, M
1.0	1R0	A0	A, B, C, D	6.2	6R2	V0	A, B, C, D	47	470	S1	F, G, J, K, M
1.1	1R1	B0	A, B, C, D	6.8	6R8	W0	B, C, J, K	51	510	T1	F, G, J, K, M
1.2	1R2	C0	A, B, C, D	7.5	7R5	X0	B, C, J, K	56	560	U1	F, G, J, K, M
1.3	1R3	D0	A, B, C, D	8.2	8R2	Y0	B, C, J, K	62	620	V1	F, G, J, K, M
1.5	1R5	E0	A, B, C, D	9.1	9R1	Z0	B, C, J, K	68	680	W1	F, G, J, K, M
1.6	1R6	F0	A, B, C, D	10	100	A1	F, G, J, K, M	75	750	X1	F, G, J, K, M
1.8	1R8	G0	A, B, C, D	11	110	B1	F, G, J, K, M	82	820	Y1	F, G, J, K, M
2.0	2R0	H0	A, B, C, D	12	120	C1	F, G, J, K, M	91	910	Z1	F, G, J, K, M
2.2	2R2	J0	A, B, C, D	15	150	E1	F, G, J, K, M	100	101	A2	F, G, J, K, M
2.4	2R4	K0	A, B, C, D	18	180	G1	F, G, J, K, M				

## HOW TO ORDER

**Series** 600  
**Case Size** S  
 See mechanical dimensions below  
**Capacitance Code** 0R2  
 EIA Capacitance Code in pF.  
 Third digit = number of zeros or after "R" significant figures  
**Capacitance Tolerance Code** B  

Code	A	B	C	D	F	G	J	K	M
Tol.	±0.05 pF	±0.1 pF	±0.25 pF	±0.5 pF	±1%	±2%	±5%	±10%	±20%

  
 The above part number refers to a 600F Series (case size F) 10 pF capacitor, J tolerance (±5%), 250 WVDC, with T termination (Tin Plated over Nickel Barrier, RoHS Compliant), Laser Marking and Tape and Reel packaging.  
**Termination Style Code** T  
 T = Tin Plated over Nickel Barrier (RoHS Compliant)  
 TN = Tin Plated Non-Magnetic Barrier  
 W = Tin/Lead Solder Nickel Barrier  
**Voltage Rating** 250  
**Laser Marking (Optional)** X\*\*  
**Packaging** T  
 T = Tape and Reel, 500 pcs  
 T4K = Tape and Reel, 4000 pcs  
 TV = Vertical Tape and Reel, 500 pcs

\*\*Laser Marking is optional

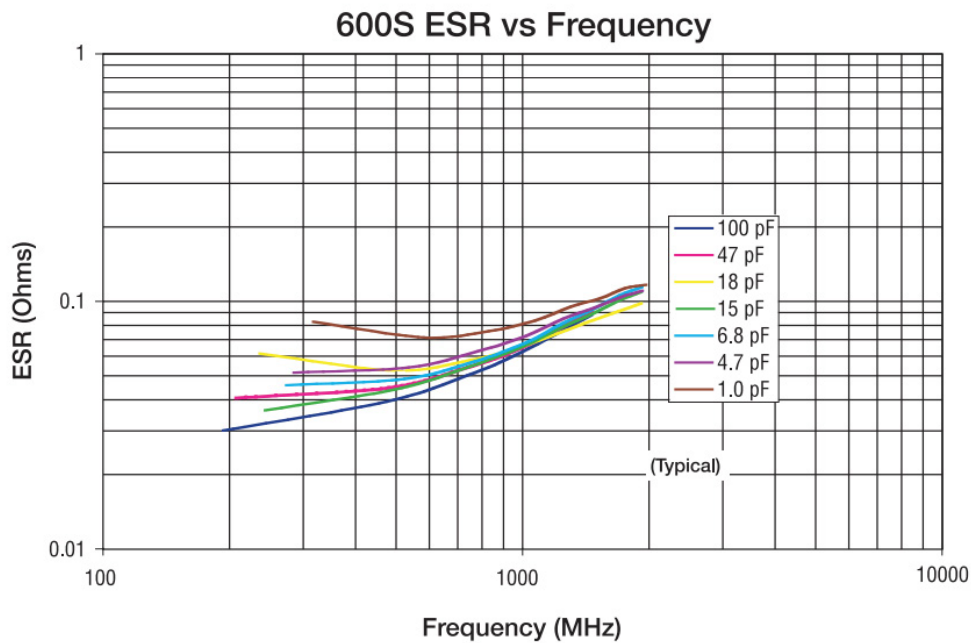
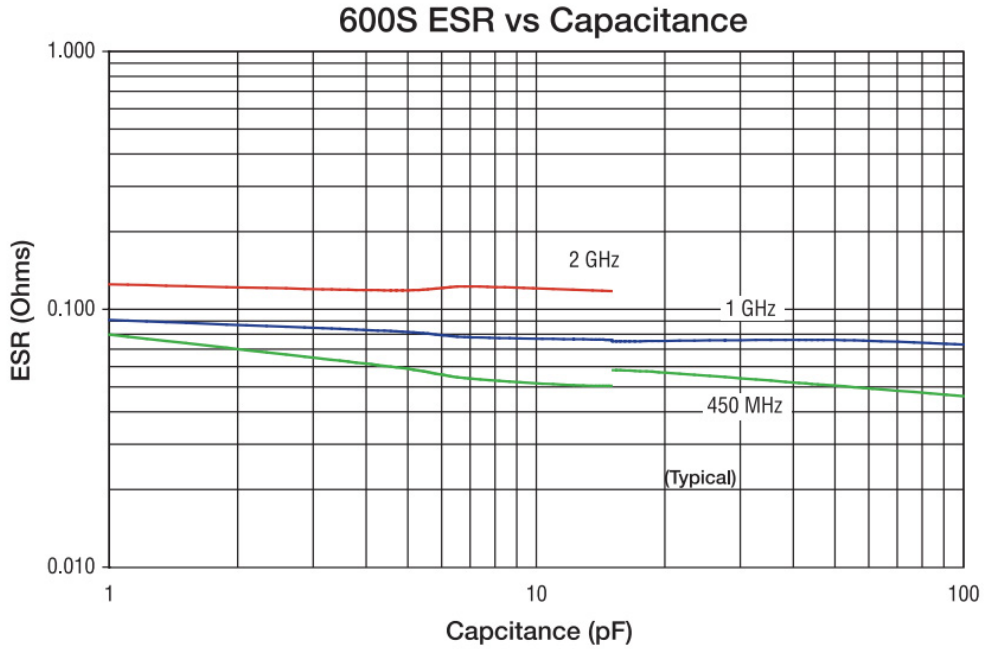

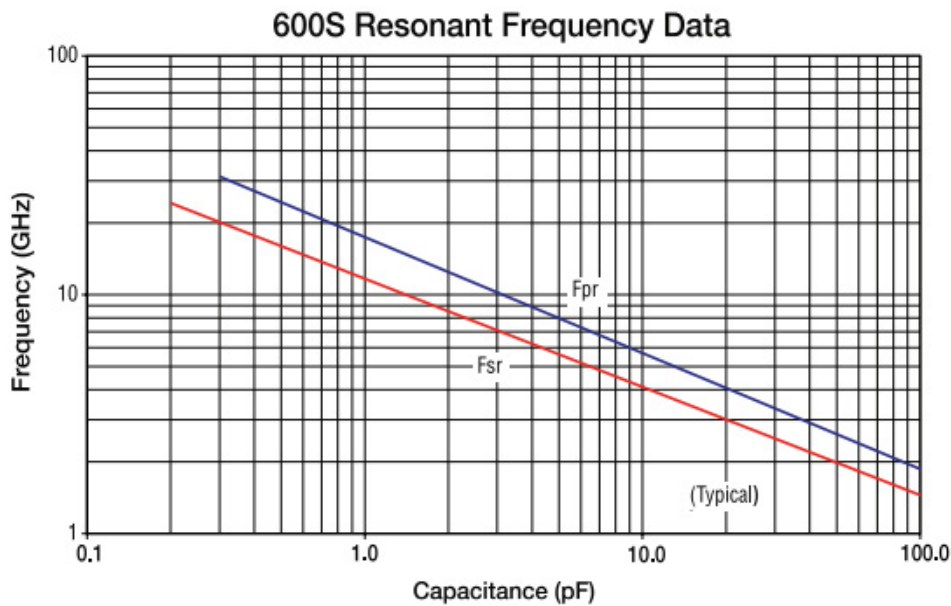
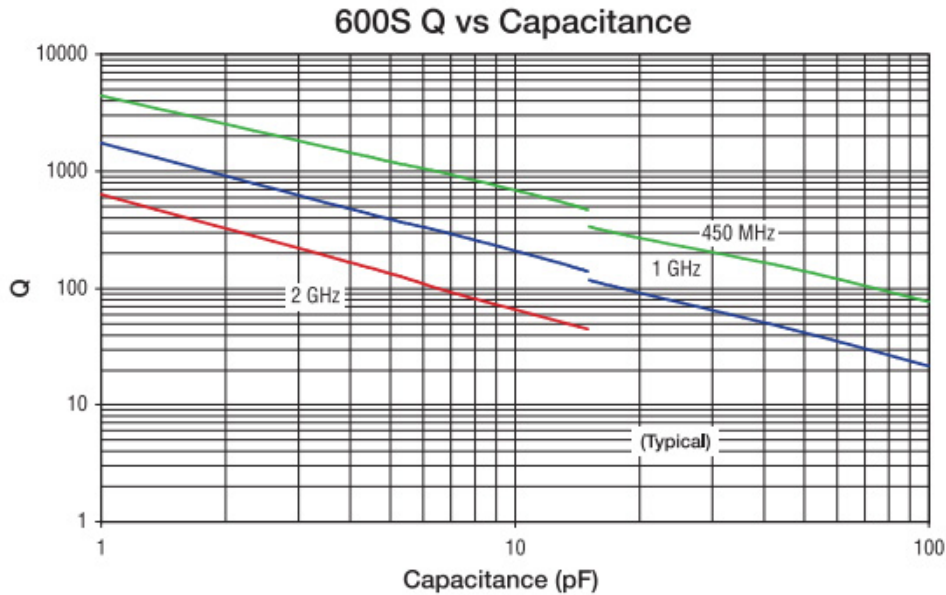

#### 600F Series Data Sheet Condition Description

Capacitors horizontally mounted on 13.3-mil thick Rogers R0435® softboard 29-mils wide 1/2 oz. Cu traces  
**FSR** = lowest frequency at which S11 response, referenced at capacitor edge, crosses real axis on Smith Chart.  
**FPR** = lowest frequency at which there is a notch in S21 magnitude response.

**RF/Microwave Capacitors**  
**RF/Microwave Multilayer Capacitors (MLC)**  
**600S Ultra-Low ESR, High Q, NPO Capacitors**



**OUTLINE DIMENSIONS**

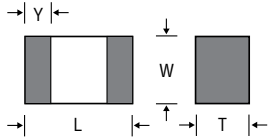

<b>S (0603)</b>	L: $.063 \pm .006$ (1.60 $\pm$ 0.15)	T: $.035$ max (0.89 max)
	W: $.032 \pm .006$ (.81 $\pm$ 0.15)	Y: $.014 \pm .006$ (0.36 $\pm$ 0.15)

inches (mm)

**SUGGESTED MOUNTING PAD DIMENSIONS**

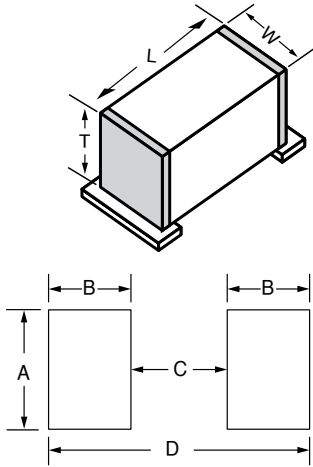

**Case Size L, S, and F**

Case Size	A Min.	B Min.	C Min.	D Min.
<b>0402 (1005)</b>	.0275 (0.70)	.0354 (0.90)	.0157 (0.40)	.0866 (2.20)
<b>0603 (1608)</b>	.0393 (1.00)	.0433 (1.10)	.0236 (0.60)	.110 (2.80)
<b>0805 (2012)</b>	.0590 (1.50)	.0512 (1.30)	.0236 (0.60)	.1259 (3.20)

inches (mm)

**DESIGN KITS**

Kit #	RoHS Compliant	Item #	Description	Cap. Value Range (pF)	Cap. Value (pF)	Tol. (pF)	Price
Kit 25T		DK0025T	600S Series Ultra-low ESR, High Q Microwave Capacitors 16 different values, 15 pcs. min. per value	0.1 to 2.0	0.1, 0.2, 0.3, 0.4, 0.5, 0.6, 0.7, 0.8, 0.9, 1.0, 1.1, 1.2, 1.5 ..... $\pm$ 0.1% 1.6, 1.8, 2.0 ..... $\pm$ 0.25%		\$100.00
Kit 26T		DK0026T	600S Series Ultra-low ESR, High Q Microwave Capacitors 16 different values, 15 pcs. min. per value	0.1 to 10	1.0, 1.2, 1.5, 1.8, 2.0, 2.2, 2.4, 2.7, 3.0, 3.3 ..... $\pm$ 0.1% 3.9, 4.7, 5.6, 6.8, 8.2 ..... $\pm$ 0.25% 10 ..... $\pm$ 5%		\$100.00
Kit 27T		DK0027T	600S Series Ultra-low ESR, High Q Microwave Capacitors 16 different values, 15 pcs. min. per value	10 to 100	10, 12, 15, 18, 20, 22, 24, 27, 30, 33, 39, 47 56, 68, 82, 100 ..... $\pm$ 5%		\$100.00

For Online Kit Orders, Catalog & Application Notes, Visit: [www.avx.com](http://www.avx.com)

# Mouser Electronics

Authorized Distributor

Click to View Pricing, Inventory, Delivery & Lifecycle Information:

## Kyocera AVX:

[600S5R1BT250XT](#) [600S0R6BT250XT](#) [600S2R0BW250XT](#) [600S0R9BW250XT](#) [600S2R7BW250XT](#)  
[600S3R0BT250XT](#) [600S1R0BT250XT](#) [600S1R2BW250XT](#) [600S1R3BT250XT](#) [600S4R7BW250XT](#)  
[600S6R8BT250XT](#) [600S0R4BT250XT](#) [600S9R1BT250XT](#) [600S5R6BT250XT](#) [600S0R5BT250XT](#) [600S1R5BT250XT](#)  
[600S0R7BT250XT](#) [600S0R1BT250XT](#) [600S1R0BW250XT](#) [600S1R1BT250XT](#) [600S5R6BW250XT](#)  
[600S1R5BW250XT](#) [600S2R0BT250XT](#) [600S0R6BW250XT](#) [600S1R2BT250XT](#) [600S7R5BT250XT](#)  
[600S7R5BW250XT](#) [600S3R3BT250XT](#) [600S1R8BW250XT](#) [600S4R7BT250XT](#) [600S3R0BW250XT](#)  
[600S3R3BW250XT](#) [600S3R9BW250XT](#) [600S0R8BW250XT](#) [600S0R8BT250XT](#) [600S8R2BW250XT](#)  
[600S2R2BW250XT](#) [600S6R2BW250XT](#) [600S6R8BW250XT](#) [600S3R9BT250XT](#) [600S3R6BT250XT](#)  
[600S2R4BT250XT](#) [600S2R2BT250XT](#) [600S0R9BT250XT](#) [600S8R2BT250XT](#) [600S2R7BT250XT](#)  
[600S9R1BW250XT](#) [600S1R8BT250XT](#) [600S6R2BT250XT](#) [600S0R3BT250XT](#) [600S0R2BT250XT](#)  
[600S4R3BT250XT](#) [600S1R6BT250XT](#) [600S0R3BW250XT](#) [600S1R3BW250XT](#) [600S5R1BW250XT](#)  
[600S2R4BW250XT](#) [600S0R1BW250XT](#) [600S0R7BW250XT](#) [600S0R5BW250XT](#) [600S0R4BW250XT](#)  
[600S1R1BW250XT](#) [600S0R2BW250XT](#) [600S3R6BW250XT](#) [600S4R3BW250XT](#) [600S1R6BW250XT](#)  
[600S7R5BT250XT5](#) [600S6R8BT250XT5](#) [600S101JTRBW](#) [600S270JTRBW](#) [600S0R6BTRBW](#) [600S1R8BTRBW](#)  
[600S1R2BTN250XT](#) [600S2R2BTN250XT](#) [600S3R3BTN250XT](#) [600S4R7BTN250XT](#) [600S5R6BTN250XT](#)  
[600S6R8BTN250XT](#) [600S8R2BTN250XT](#) [600S9R1BTN250XT](#) [600S0R1BP250XT](#) [600S0R2BP250XT](#)  
[600S0R3BP250XT](#) [600SOR1BT250XT](#) [600S9R1BP250XT](#) [600S8R2BP250XT](#) [600S7R5BP250XT](#)  
[600S6R2BP250XT](#) [600S6R8BP250XT](#) [600S5R1BP250XT](#) [600S5R6BP250XT](#) [600S4R0BT250XT](#) [600S4R3BP250XT](#)  
[600S4R7BP250XT](#) [600S3R6BP250XT](#) [600S3R9BP250XT](#) [600S3R0BP250XT](#) [600S3R3BP250XT](#)  
[600S2R4BP250XT](#) [600S2R7BP250XT](#)